



GIZA L4 TRACK HORIZONTAL

15W LED Three-Phase Track Spot Luminaire

Order Code : 3270722
Product Code : GZA 015F 40LN00 50 1K4 20 L4 HR ADJ FLP



Product Data

Standard Features

Housing	: Aluminium Housing
Diffuser	: 50° Lens + Reflector
IP Grade	: IP20
Installation	: Three-Phase Track
Light Source	: Mid Power LED
Electronic Control	: On/Off

Optical & Electrical Features

Power Consumption	: 14,7 W
Final Luminous Flux	: 1421 lm
Efficacy	: 96.67 lm/W
Input Voltage	: 220-240 V AC
Frequency	: 50-60 Hz
Power Factor	: Cos Ø > 0,9
Correlated Color Temperature	: 4000K
Color Rendering Index	: >80

* There is ± 10% Tolerance in Technical Values.

Other Features & Conditions

Operating Temperature Range	: -5 °C / +35 °C
Impact Resistance	: IK03
Led Life Time - L70	: > 72.000 hours @Ta= 35 °C

Photometric Curve

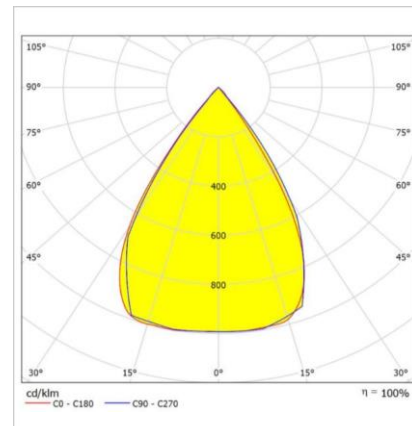

Optional Features

Correlated Color Temperatures	: 2700K / 3000K / 6500K
Emergency Kit Options	: No
DALI Option	: Yes
Degree Option	: 80°

GIZA L4 TRACK HORIZONTAL

15W LED Three-Phase Track Spot Luminaire

3270722 GZA 015F 40LN00 50 1K4 20 L4 HR ADJ FLP

Dimensions (mm)

	a	b	h	h1	h2
Standard	170	50	52	82	132

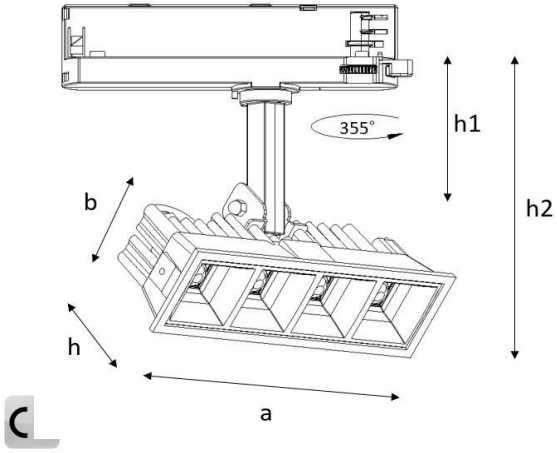

Rail Installation



① - ②

Key rail socket is inserted to Three-phase - Single-phase Rail in an oblique manner.



③ - ④

Locking catch on key rail socket is turned as shown, then assembly process is complete.

- EAE, reserves the right to make changes without prior notice.

engineering the light

EAE Aydınlatma A.Ş.
İkitelli Organize Sanayi Bölgesi Eski Turgut Özal Caddesi No:20 Başakşehir / İSTANBUL-TURKEY
Phone: +90 212 413 21 00 (pbx) Fax: +90 212 549 37 90
www.eaeaydinlatma.com.tr

Revision date: 24.06.2024



TRACK SYSTEM Ordering Table

Ordering Code	Product Codes	Descriptions
3061351	TRIFAZE RAY 1MT GRI SIVA USTU FLP	Surface 3-Phase Lighting Tracks - Grey 1000(mm)
3061352	TRIFAZE RAY 1MT SIYAH SIVA USTU FLP	Surface 3-Phase Lighting Tracks - Black 1000(mm)
3061350	TRIFAZE RAY 1MT BEYAZ SIVA USTU FLP	Surface 3-Phase Lighting Tracks - White 1000(mm)
3061356	TRIFAZE RAY 2MT SIYAH SIVA USTU FLP	Surface 3-Phase Lighting Tracks - Black 2000(mm)
3061354	TRIFAZE RAY 2MT BEYAZ SIVA USTU FLP	Surface 3-Phase Lighting Tracks - White 2000(mm)
3061360	TRIFAZE RAY 3MT SIYAH SIVA USTU FLP	Surface 3-Phase Lighting Tracks - Black 3000(mm)
3061359	TRIFAZE RAY 3MT BEYAZ SIVA USTU FLP	Surface 3-Phase Lighting Tracks - White 3000(mm)

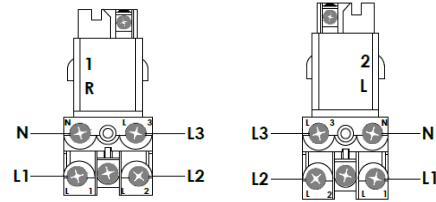
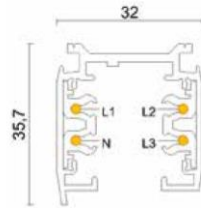

Ordering Code	Product Codes	Descriptions
3056387	TRIFAZE RAY 1MT BEYAZ SIVA ALTI FLP	Recessed 3-Phase Lighting Tracks - White 1000(mm)
3056390	TRIFAZE RAY 2MT BEYAZ SIVA ALTI FLP	Recessed 3-Phase Lighting Tracks - White 2000(mm)
3056393	TRIFAZE RAY 3MT BEYAZ SIVA ALTI FLP	Recessed 3-Phase Lighting Tracks - White 3000(mm)
3159825	TRIFAZE RAY 1MT SIYAH SIVA ALTI FLP	Recessed 3-Phase Lighting Tracks - Black 1000(mm)
3159824	TRIFAZE RAY 2MT SIYAH SIVA ALTI FLP	Recessed 3-Phase Lighting Tracks - Black 2000(mm)
3159826	TRIFAZE RAY 3MT SIYAH SIVA ALTI FLP	Recessed 3-Phase Lighting Tracks - Black 3000(mm)
3056391	TRIFAZE RAY 2MT GRI SIVA ALTI FLP	Recessed 3-Phase Lighting Tracks - Grey 2000(mm)

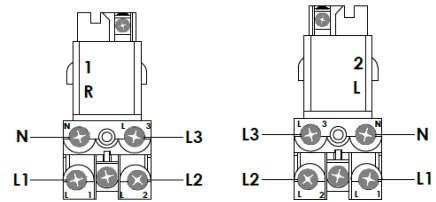
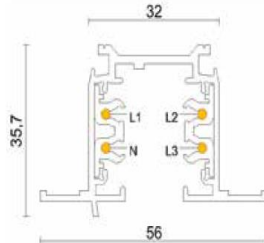
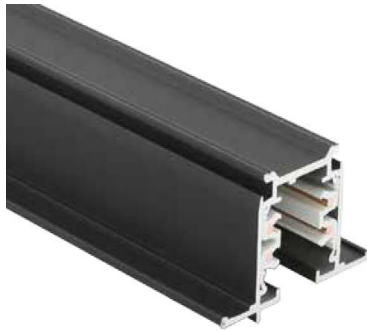

Ordering Code	Product Codes	Descriptions
3081749	TRIFAZE RAY SOKETI GRI FLP	3 Circuits Adapter - Grey
3062139	TRIFAZE RAY SOKETI SIYAH FLP	3 Circuits Adapter - Black
3081748	TRIFAZE RAY SOKETI BEYAZ FLP	3 Circuits Adapter - White



engineering the light

TRACK SYSTEM Ordering Table

Ordering Code	Product Codes	Descriptions
3056466	TRIFAZE RAY ENERJI GIRIS GRI FLP	3 Circuits Track Live-end Connector - Grey
3056465	TRIFAZE RAY ENERJI GIRIS SIYAH FLP	3 Circuits Track Live-end Connector - Black
3056464	TRIFAZE RAY ENERJI GIRIS BEYAZ FLP	3 Circuits Track Live-end Connector - White



L



R

Ordering Code	Product Codes	Descriptions
3056282	TRIFAZE RAY ARA BAGLANTI UZUN SIYAH FLP	3 Circuits Track Middle Connector - Black
3056281	TRIFAZE RAY ARA BAGLANTI UZUN BEYAZ FLP	3 Circuits Track Middle Connector - White
3358331	TRIFAZE RAY ARA BAGLANTI UZUN GRI FLP	3 Circuits Track Middle Connector - Grey

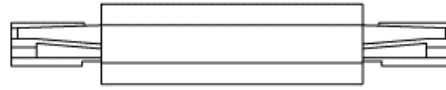

Ordering Code	Product Codes	Descriptions
3056410	TRIFAZE RAY ARA BAGLANTI SIYAH FLP	3 Circuits Track Mini Joiner - Black
3056408	TRIFAZE RAY ARA BAGLANTI BEYAZ FLP	3 Circuits Track Mini Joiner - White
3358332	TRIFAZE RAY ARA BAGLANTI GRI FLP	3 Circuits Track Mini Joiner - Grey

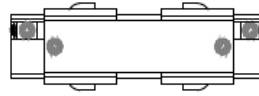

Ordering Code	Product Codes	Descriptions
3061346	TRIFAZE RAY T BAGLANTI BEYAZ FLP	3 Circuits Track T Connector - White
3358450	TRIFAZE RAY T BAGLANTI GRI FLP	3 Circuits Track T Connector - Grey
3358454	TRIFAZE RAY T BAGLANTI SIYAH FLP	3 Circuits Track T Connector - Black

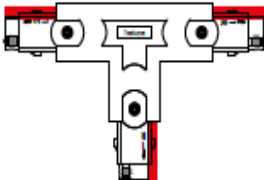

L1

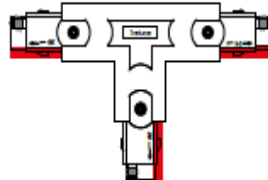

L2

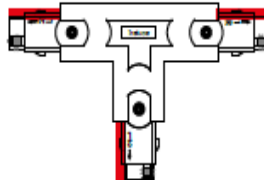

R1

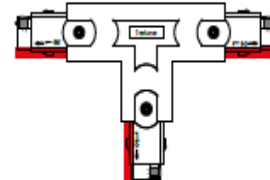

R2

engineering the light

TRACK SYSTEM Ordering Table

Ordering Code	Product Codes	Descriptions
3056491	TRIFAZE RAY L BAGLANTI SIYAH FLP	3 Circuits Track T Connector -Black
3056489	TRIFAZE RAY L BAGLANTI BEYAZ FLP	3 Circuits Track T Connector -White
3358334	TRIFAZE RAY L BAGLANTI GRI FLP	3 Circuits Track T Connector -Grey

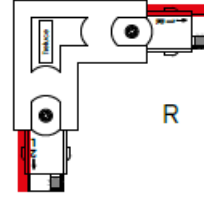
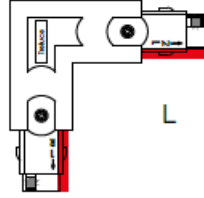

Ordering Code	Product Codes	Descriptions
3056284	TRIFAZE RAY KAPAK SONLANDIRMA GRI FLP	3 Circuits Track End Cap Grey
3056285	TRIFAZE RAY KAPAK SONLANDIRMA SIYAH FLP	3 Circuits Track End Cap Black
3056283	TRIFAZE RAY KAPAK SONLANDIRMA BEYAZ FLP	3 Circuits Track End Cap White

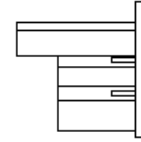

Ordering Code	Product Codes	Descriptions
3056386	TRIFAZE RAY TAVAN TASYICI SIYAH FLP	3 Circuits Track Ceiling Carrier Black
3156544	TRIFAZE RAY TAVAN TASYICI BEYAZ FLP	3 Circuits Track Ceiling Carrier White
3358460	TRIFAZE RAY TAVAN TASYICI GRI FLP	3 Circuits Track Ceiling Carrier Grey

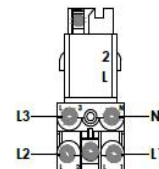
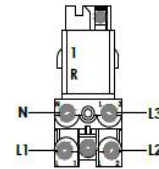

engineering the light